

**Now You Can Browse & Research Our Products On-line!**

***www.chemglass.com***

View our complete catalog of over 8,000 products!

- User friendly and secure ordering forms
- Convenient shopping hours (Yours!)
- Full color photos and detailed diagrams
- See your customized discount levels right on-line!



**Shop like you would in our Catalog!**

**CHEMGLASS**

*Scientific Apparatus Since 1946*

3800 North Mill Road • Vineland NJ 08360  
U.S. and Canada phone: 1-800-843-1794  
Fax: 1-800-922-4361  
customer-service@chemglass.com  
www.chemglass.com

# 2008

**BEST FOR LESS**

Starting January 1, 2008 we are pleased to offer our most popular components at special reduced prices.

All of these components are manufactured entirely at Chemglass and meet our stringent quality control standards.

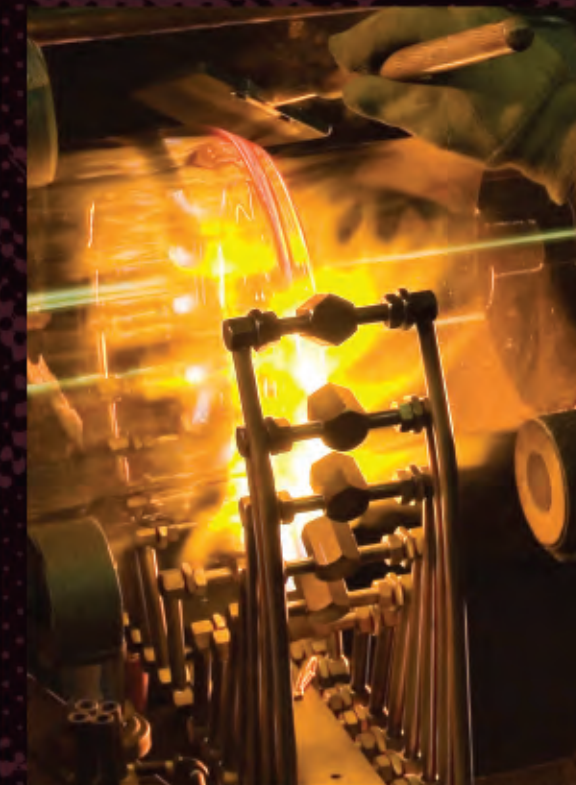

No minimum order is required to receive the special reduced pricing.

All the items included in this special offer, along with most of our glassblowing components are available for shipment within 24 hours after receipt of order.

To make sure you receive the prices listed, please order using the CGB prefix. PRICES NET AS SHOWN.

This offer expires on December 31, 2008.

To take advantage of our reduced pricing, call 1-800-843-1794 today with your order.

CALL TODAY 1-800-843-1794

**CHEMGLASS**

*Scientific Apparatus Since 1946*

3800 North Mill Road • Vineland NJ 08360  
U.S. and Canada phone: 1-800-843-1794  
Fax: 1-800-922-4361  
customer-service@chemglass.com  
www.chemglass.com

### CGB-100 GROUND JOINT, INNER, FULL LENGTH

Part Number	Joint Size	Tubing O.D. x Wall mm	Price Each
CGB-100-04	14/35	12.7 x 1.6	\$3.20
CGB-100-05	19/38	17.0 x 1.8	\$3.70
CGB-100-06	24/40	22 x 1.8	\$2.60
CGB-100-07	29/42	28 x 2.0	\$3.95
CGB-100-08	34/45	32 x 2.4	\$5.30
CGB-100-10	45/50	41 x 2.0	\$7.80
CGB-100-12	55/50	51 x 2.0	\$9.80

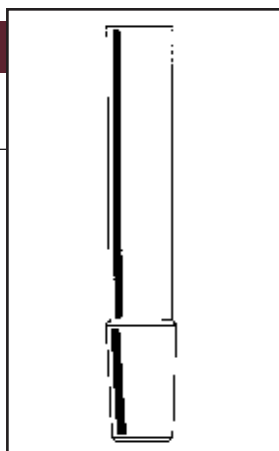

### CGB-101 GROUND JOINT, OUTER, FULL LENGTH

Part Number	Joint Size	Tubing O.D. x Wall mm	Price Each
CGB-101-04	14/35	19 x 1.8	\$3.40
CGB-101-05	19/38	22 x 1.8	\$3.90
CGB-101-06	24/40	28 x 2.0	\$2.30
CGB-101-07	29/42	32 x 2.4	\$3.55
CGB-101-08	34/45	38 x 2.0	\$6.45
CGB-101-10	45/50	48 x 2.3	\$8.80
CGB-101-12	55/50	60 x 2.4	\$10.90

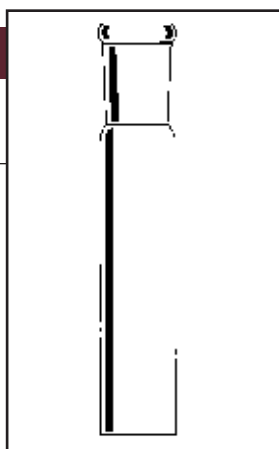

### CGB-103 GROUND JOINT, OUTER, FULL LENGTH

Part Number	Joint Size	Tubing O.D. x Wall mm	Price Each
CGB-103-06	24/40	28 x 2.0	\$3.80
CGB-103-07	29/42	32 x 2.4	\$4.40
CGB-103-10	45/50	48 x 2.0	\$9.05



### CGB-104 GROUND JOINT, INNER, MEDIUM LENGTH

Part Number	Joint Size	Tubing O.D. x Wall mm	Price Each
CGB-104-05	10/18	8.00 x 1.5	\$2.80
CGB-104-08	14/20	12.7 x 1.6	\$3.00
CGB-104-09	19/22	17.0 x 1.8	\$3.10



### CGB-428 STOPCOCK, STRAIGHT BORE 1-ARM LARGER, TEFLON

Part Number	Bore mm	Plug Size	Sidearm O.D. mm	Price Each
CGB-428-01	2	11/25	8 & 10	\$11.75
CGB-428-02	4	15.2/30	10 & 12	\$17.96
CGB-428-03	6	16/35	11 & 12	\$22.10

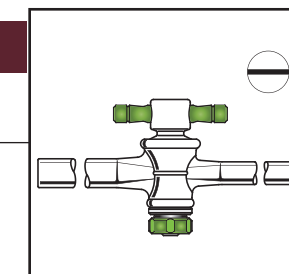

### GLASS SHELL ONLY

CGB-428-20	2	11/25	8 & 9	\$8.18
CGB-428-22	4	15.2/30	10 & 12	\$13.30
CGB-428-24	6	16/35	11 & 12	\$14.85

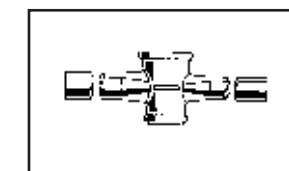

### CGB-934 VALVE, TFE, O-RING, HIGH VACUUM, 1-ARM

Part Number	Bore mm	O-ring Type	Price Each
CGB-934-01	0-4	Viton	\$16.15
CGB-934-02	0-8	Viton	\$23.91
CGB-934-03	0-12	Viton	\$25.05

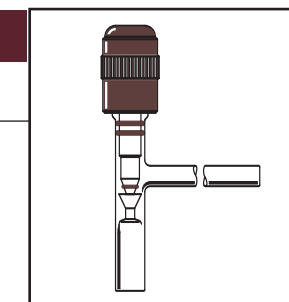

### CGB-960 VALVE, CHEM-CAP®, HIGH VACUUM, 1-ARM

Part Number	Bore mm	Price Each
CGB-960-01	0-4	\$18.22
CGB-960-02	0-8	\$24.17
CGB-960-03	0-12	\$27.22

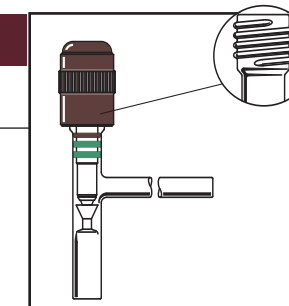

All standard tapered joints are produced in the U.S.A. on our automated equipment or hand tooled

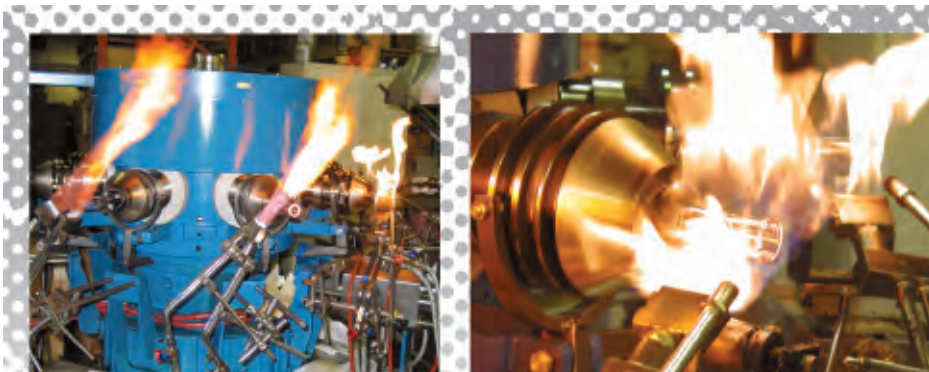

Automated tooling equipment at work



PROUDLY  
Made in the U.S.A.

**CHEMGLASS**  
Scientific Apparatus Since 1946

3800 North Mill Road • Vineland NJ 08360  
U.S. and Canada phone: 1-800-843-1794  
Fax: 1-800-922-4361  
customer-service@chemglass.com  
www.chemglass.com

TO ORDER CALL: 1-800-843-1794

**CGB-125 GROUND JOINT, FLASK LENGTH**

Part Number	Joint Size	Tubing O.D. x Wall mm	Price Each
CGB-125-01	9	11 x 1.5	\$3.10
CGB-125-02	13	15 x 1.2	\$3.40
CGB-125-03	16	17 x 1.8	\$3.50
CGB-125-04	19	19 x 1.8	\$4.00
CGB-125-05	22	22 x 1.8	\$4.10
CGB-125-06	27	25 x 1.5	\$4.40
CGB-125-09	38	45 x 2.0	\$6.00

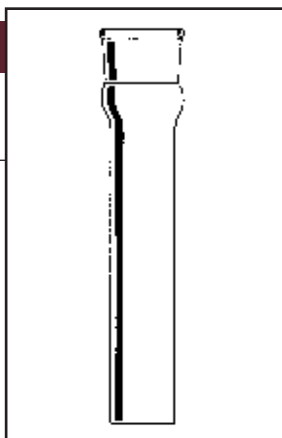
**CGB-170 GROUND JOINT, RODAVISS®, INNER**

Part Number	Joint Size	Price Each
CGB-170-01	14/20	\$3.90
CGB-170-05	24/40	\$4.10
CGB-170-08	45/50	\$11.00

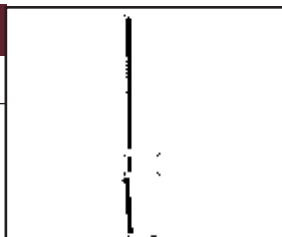
**CGB-172 GROUND JOINT, RODAVISS®, OUTER**

Part Number	Joint Size	Price Each
CGB-172-01	14/20	\$3.90
CGB-172-05	24/40	\$4.80
CGB-172-08	45/50	\$12.00

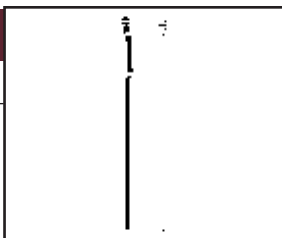
**CGB-182 JOINT CAP, WITH HOLE, RODAVISS®**

Part Number	Size	Price Each
CGB-182-01	14	\$.87
CGB-182-03	24	\$1.13
CGB-182-06	45	\$3.32

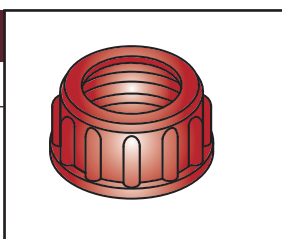
**CGB-184 LOOSENING RING, POLYPROPYLENE, RODAVISS®**

Part Number	Size	Price Each
CGB-184-01	14	\$.43
CGB-184-03	24	\$.43
CGB-184-06	45	\$.59

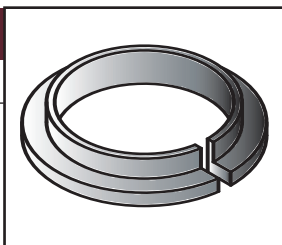
**CGB-194 SCREW THREAD TUBE, GL**

Part Number	GL Size	Tubing Dimensions O.D. x Wall mm	Overall Length mm	Tubing I.D. mm	Price Each
CGB-194-01	14	12 x 1.5	100	8.45	\$1.75
CGB-194-02	18	16 x 1.8	100	11	\$2.00
CGB-194-03	25	22 x 1.8	100	18	\$3.05
CGB-194-04	32	28 x 2.0	100	23	\$4.45
CGB-194-05	45	40 x 2.3	100	34.5	\$6.80

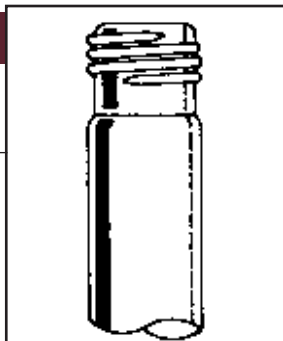
**CGB-195 / CGB-196 CAPS, FOR GL THREAD**

CGB-195 CAPS WITH APERTURE			CGB-196 SOLID CAPS		
Part Number	GL Size	Price Each	Part Number	GL Size	Price Each
CGB-195-01	14	\$.86	CGB-196-01	14	\$1.13
CGB-195-02	18	\$.88	CGB-196-02	18	\$1.24
CGB-195-03	25	\$1.06	CGB-196-03	25	\$1.45
CGB-195-04	32	\$1.18	CGB-196-04	32	\$2.20
CGB-195-05	45	\$2.04	CGB-196-05	45	\$3.33

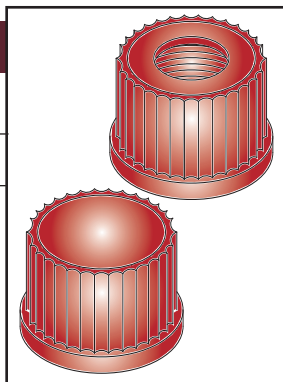
**CGB-201 FRITTED FILTER DISC**

Part Number	Disc O.D. mm	Porosity	Price Each
CGB-201-01	10	F	\$3.38
CGB-201-02	10	M	\$2.58
CGB-201-03	10	C	\$2.58
CGB-201-04	10	XC	\$2.58
CGB-201-05	12	F	\$3.38
CGB-201-06	12	M	\$2.95
CGB-201-07	12	C	\$2.95
CGB-201-08	12	XC	\$2.95
CGB-201-09	15	F	\$3.38
CGB-201-10	15	M	\$3.05
CGB-201-11	15	C	\$3.05
CGB-201-12	15	XC	\$3.05
CGB-201-13	20	F	\$5.18
CGB-201-14	20	M	\$3.62
CGB-201-15	20	C	\$3.62
CGB-201-16	20	XC	\$3.62
CGB-201-17	25	F	\$4.32
CGB-201-18	25	M	\$3.70
CGB-201-19	25	C	\$3.70
CGB-201-20	25	XC	\$3.70
CGB-201-21	30	F	\$6.32
CGB-201-22	30	M	\$4.68
CGB-201-23	30	C	\$4.68
CGB-201-24	30	XC	\$4.68
CGB-201-25	35	F	\$6.28
CGB-201-26	35	M	\$5.68
CGB-201-27	35	C	\$5.68
CGB-201-28	35	XC	\$5.68
CGB-201-29	40	F	\$7.87
CGB-201-30	40	M	\$7.17
CGB-201-31	40	C	\$7.17
CGB-201-32	40	XC	\$7.17

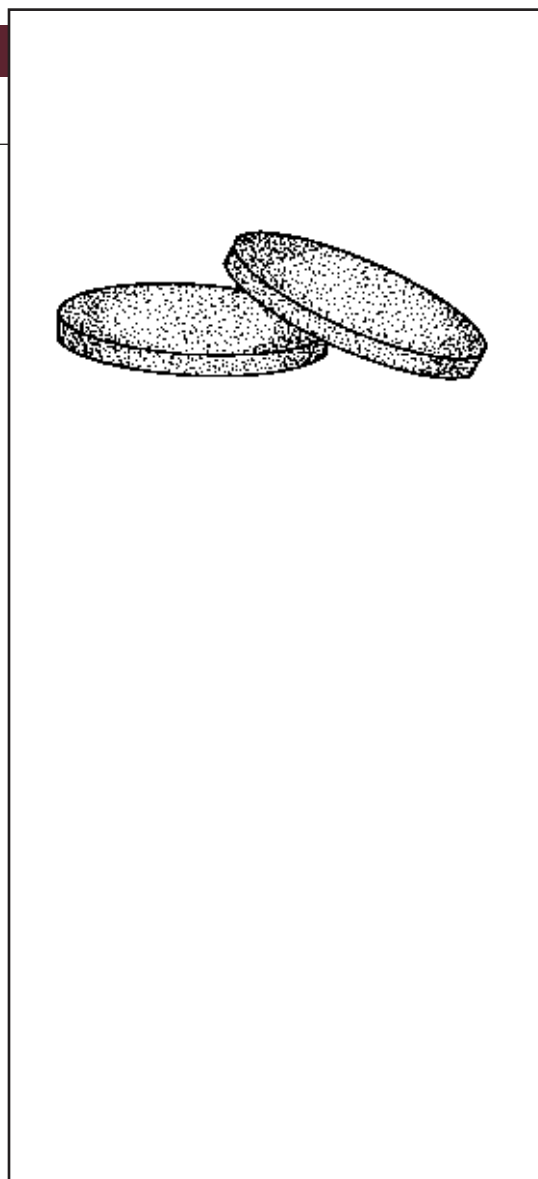
**ORDERING INFORMATION**

To place an order, please specify part number and quantity. To take advantage of the reduced pricing, order using the CGB prefix.

Phone: 1-800-843-1794

Fax: 1-800-922-4361

E-mail: [customer-service@chemglass.com](mailto:customer-service@chemglass.com)

### CGB-300 GLASSBLOWERS HOSE CONNECTIONS

Dimensions (mm)							
Part Number	No. of Rings	"A"	"B"	"C"	"D"	"E"	Price/ Pk. 10
CGB-300-01	3	3.0	8.0	9	16	8	\$9.20
CGB-300-02	4	5.0	10.0	11	20	10	\$9.65

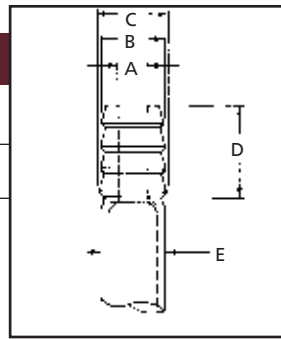

### CGB-301 GLASSBLOWERS HOSE CONNECTION, DIRECT SEALING

Dimensions (mm)							
Part Number	No. of Rings	"A"	"B"	"C"	"D"	"E"	Price/ Pk. 10
CGB-301-01	3	4.0	8.0	10	18	10	\$10.30
CGB-301-02	4	5.0	12.0	14	24	12	\$14.20

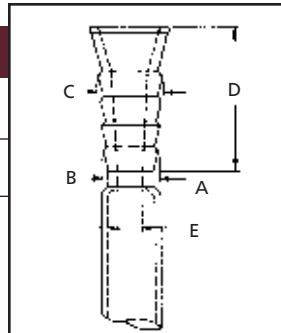

### CGB-360 INTERNAL THREAD, GLASS PORTION ONLY

Part Number	Size	Tube O.D. mm	Accepts Tubing O.D.	Price Each
CGB-360-01	#7	12.7	6-7mm	\$3.80
CGB-360-02	#11	16	9-10.5mm	\$4.85
CGB-360-03	#15	22	12.5-14mm	\$5.50
CGB-360-05	#25	32	24-25mm	\$6.75
CGB-360-06	#50	57	47-48mm	\$17.90

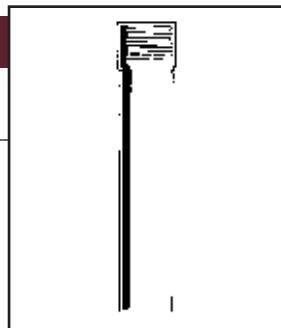

### CGB-400 STOPCOCK, STRAIGHT BORE, GLASS PLUG

Part Number	Bore mm	Plug Size	Sidearm O.D. mm	Clip Size	Price Each
CGB-400-02	2	12/30	8	#1	\$13.00
CGB-400-04	4	17/40	10	#4	\$14.50

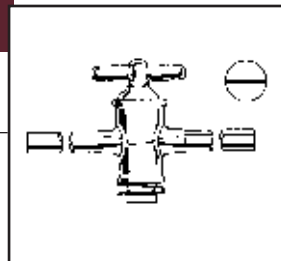

### CGB-424 STOPCOCK, STRAIGHT BORE TEFLON

Part Number	Bore mm	Plug Size	Sidearm O.D. mm	Price Each
CGB-424-03	2	11/25	8	\$12.80
CGB-424-05	4	15.2/30	10	\$18.80
CGB-424-07	6	16/35	12	\$22.90

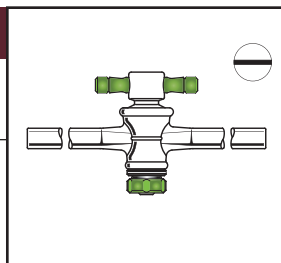

### CGB-426 STOPCOCK, GLASS SHELL ONLY, FOR TEFLON PLUG

Part Number	Bore mm	Plug Size	Sidearm O.D. mm	Price Each
CGB-426-03	1, 1.5 & 2	11/25	8	\$9.10
CGB-426-05	3 & 4	15.2/30	10	\$13.80
CGB-426-07	5 & 6	16/35	12	\$15.20

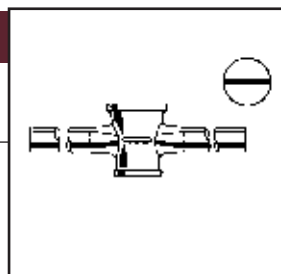

### CGB-105 GROUND JOINT, OUTER, MEDIUM LENGTH

Part Number	Joint Size	Tubing O.D. x Wall mm	Price Each
CGB-105-04	10/18	14 x 1.2	\$3.00
CGB-105-06	14/20	19 x 1.8	\$2.60
CGB-105-07	19/22	22 x 1.8	\$2.90

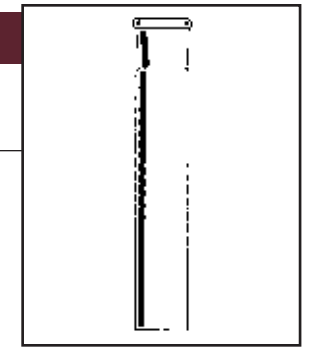

### CGB-106 DBL, DOUBLE ENDED JOINTS

Part Number	Joint Size	Tubing O.D. x Wall mm	Price Each
CGB-106-01 DBL	24/40	28 x 2.0	\$4.90
CGB-106-02 DBL	24/40	32 x 2.4	\$5.50

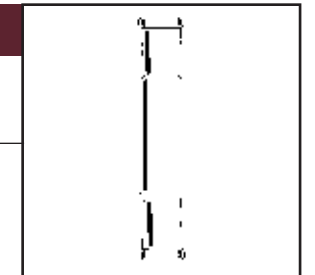

### CGB-117 GROUND JOINT, INNER, WITH DRIP TIP, UNCUT

Part Number	Joint Size	Price Each
CGB-117-01	14/20	\$3.60
CGB-117-03	19/22	\$3.65
CGB-117-13	24/40	\$4.05
CGB-117-19	45/50	\$9.85

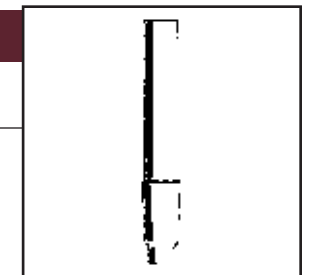

### CGB-120 SPHERICAL JOINT, BALL MEMBER

Part Number	Joint Size	Clamp Size	Tube O.D. mm	Price Each
CBG-120-04	12/5	12	8.0	\$3.90
CGB-120-06	18/9	18	13.0	\$3.90
CGB-120-08	28/15	28	19.0	\$4.20
CGB-120-09	35/20	35	22.0	\$6.20
CGB-120-10	35/25	35	28.0	\$6.30

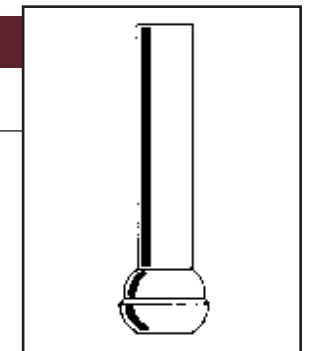

### CGB-121 SPHERICAL JOINT, SOCKET MEMBER

Part Number	Joint Size	Clamp Size	Tube O.D. mm	Price Each
CBG-121-04	12/5	12	8.0	\$3.15
CGB-121-06	18/9	18	13.0	\$3.30
CGB-121-08	28/15	28	19.0	\$3.75
CGB-121-09	35/20	35	22.0	\$4.40
CGB-121-10	35/25	35	28.0	\$4.50

